

Codice Prodotto <i>Product Code</i>	9.267.002.00	 Fornito Privo di Lubrificante! Supplied without oil!
Descrizione <i>Description</i>	T-27A	

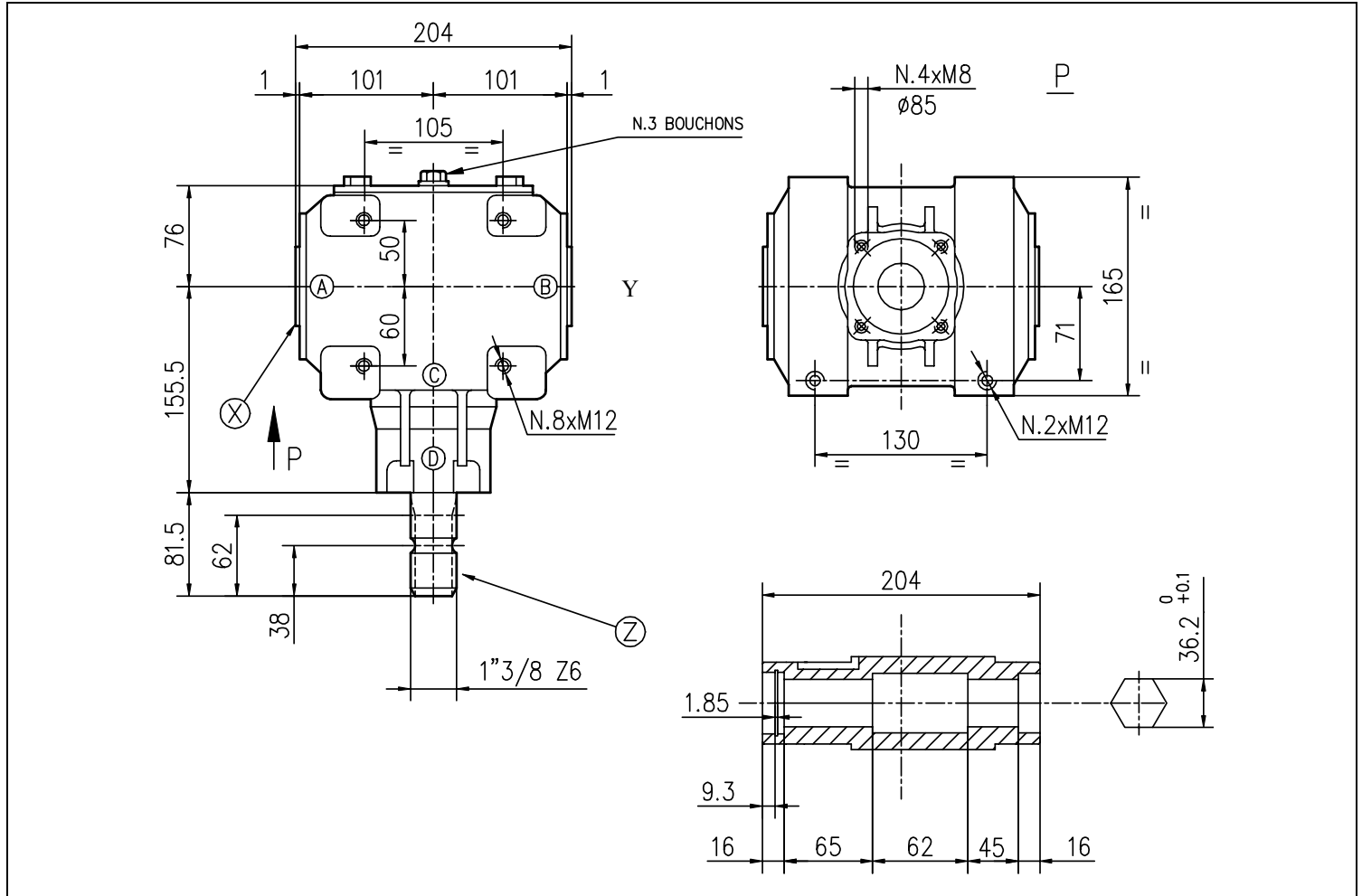
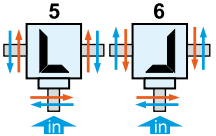
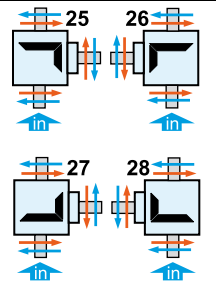

Tipo * Type *	Rapporto Ratio	Giri entrata Input r.p.m.	Potenza entrata Input Power [kW]	Momento Torcente Uscita Output Torque [daNm]	Peso Weight [kg]	Albero Ingresso Input shaft	Sensi di Rotazione Direction of Rotation
R	1,92:1	540	15,1	49,6	22	Z	
M	1:1,92	540	22,1	19,7		X-Y	

* Tipo: M= Moltiplicatore di Giri R= Riduttori di Giri O= Rinvio 1:1 RC= Riduttore Cambio di Velocità RM= Moltiplicatore Cambio di Velocità

* Type: M= Speed Increaser R= Reducer O= Gearbox 1:1 RC= Speed-Change Reducer RM= Speed-Change Increaser